







Maxi Twin

Télécommande



-  Lever
-  Baisser
-  Position allongée
-  Position assise
-  Rapprocher les pieds du châssis
-  Écarter les pieds du châssis

Arrêt d'urgence

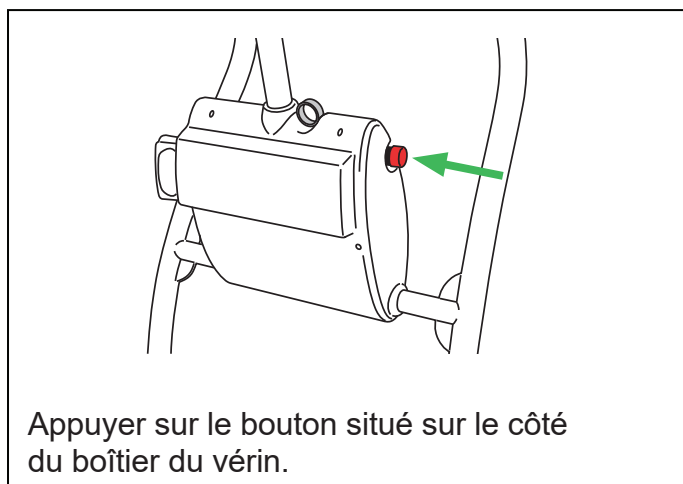

Descente d'urgence

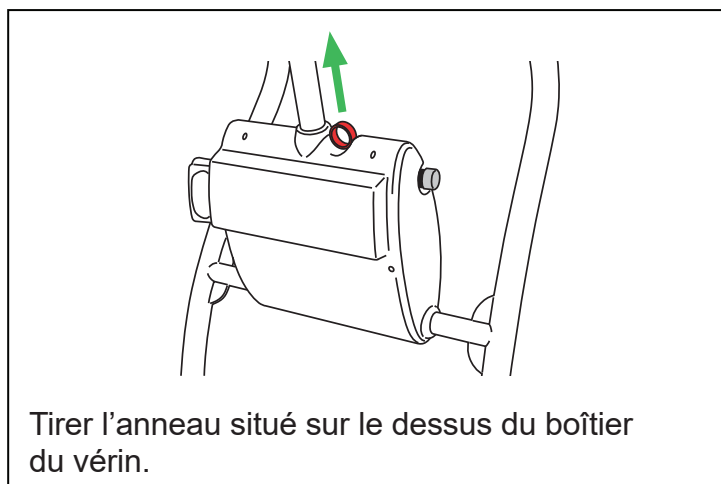

Freins

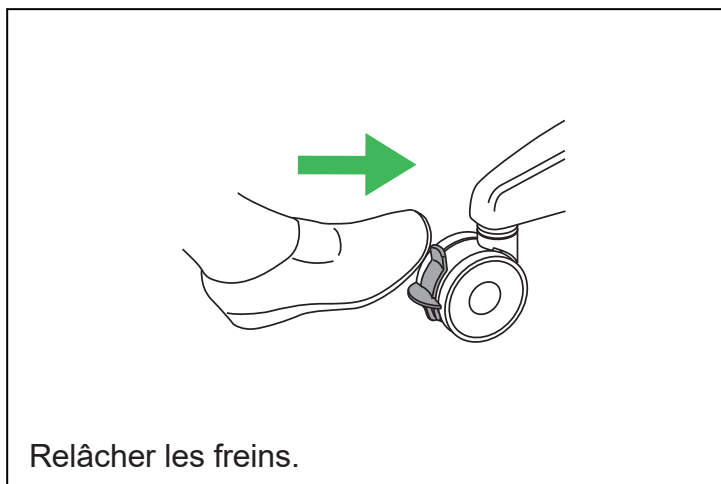
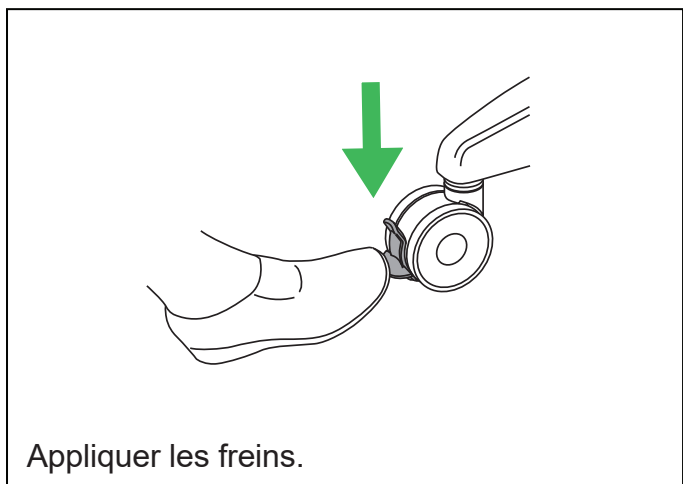

Réglage en largeur des pieds de châssis

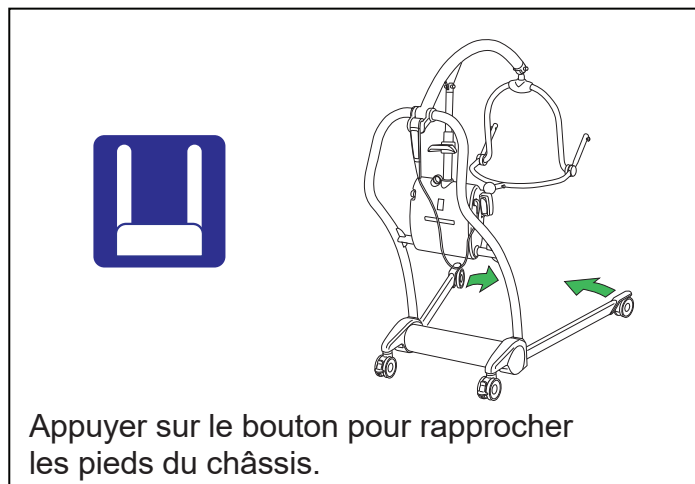
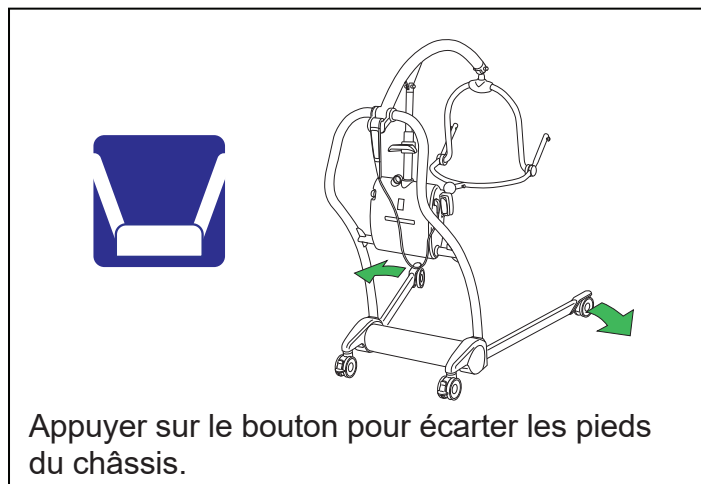

Attacher le harnais

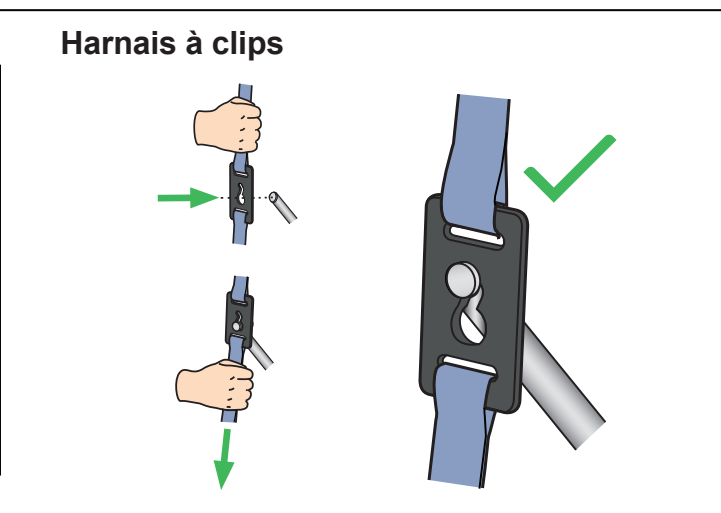
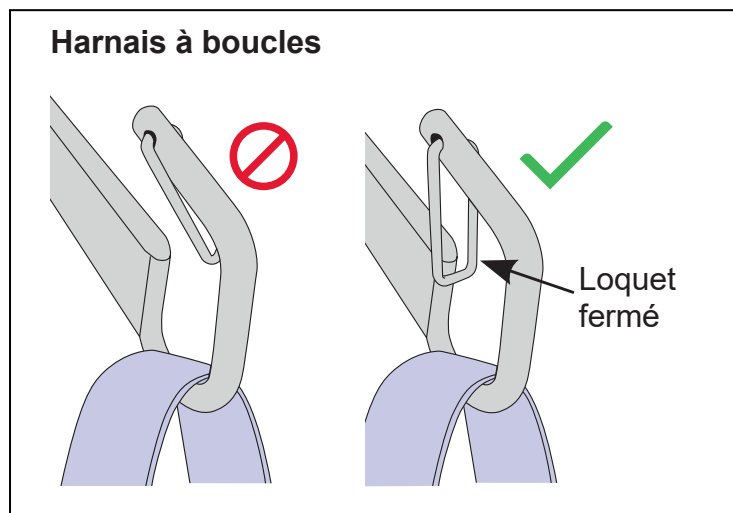

Détacher le harnais

