







Maxi Twin

Pulsantiera di controllo



-  Sollevamento
-  Discesa
-  Posizione reclinata
-  Posizione seduta
-  Chiudere le gambe dello chassis
-  Aprire le gambe dello chassis

Arresto di emergenza

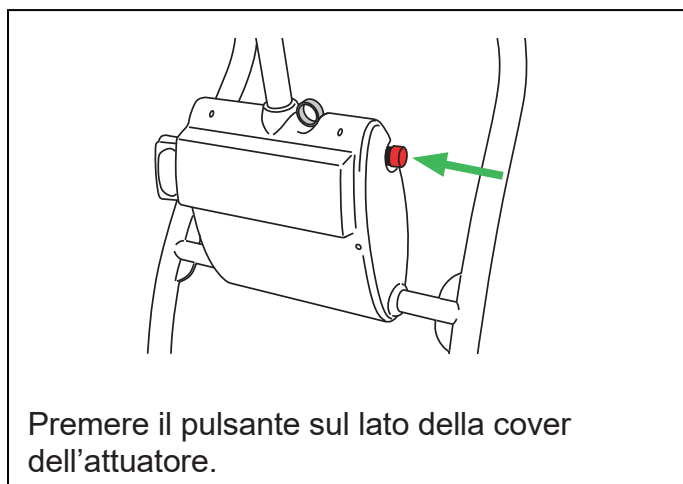

Discesa di emergenza

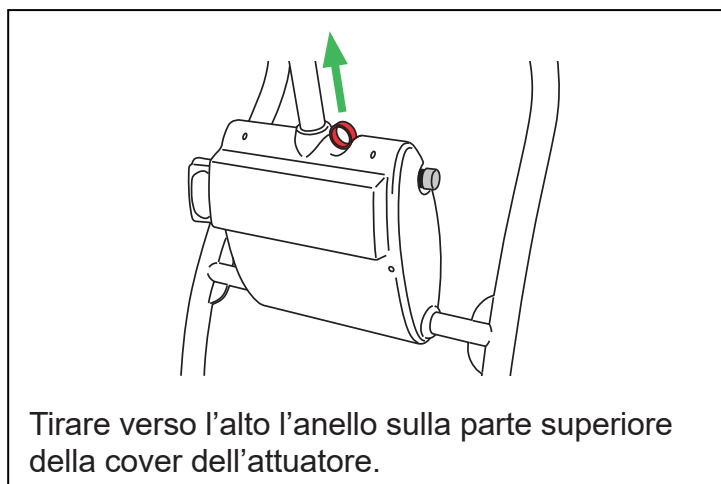

Freni

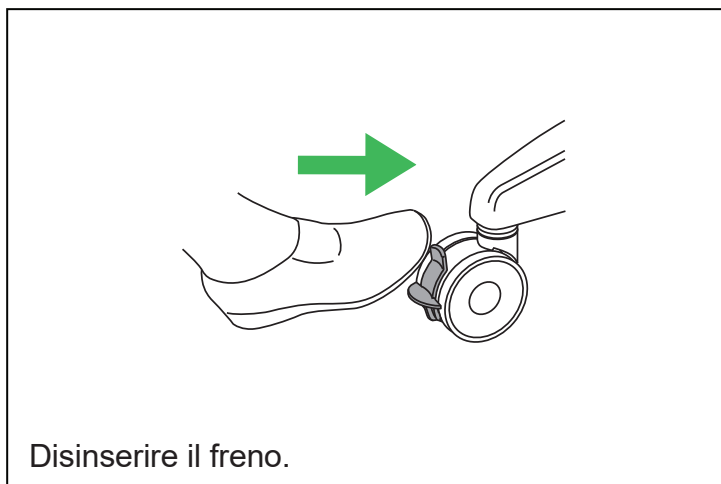
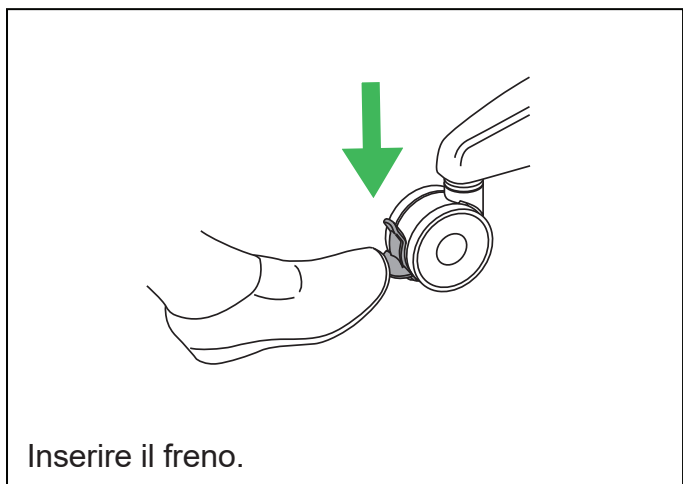

Gambe dello chassis regolabili

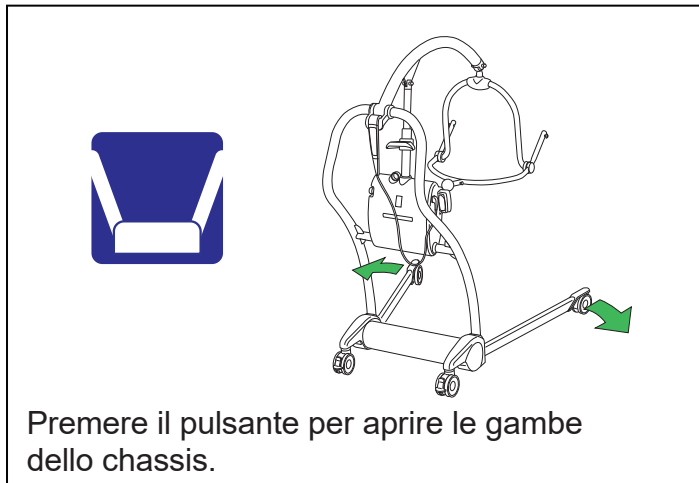

Fissare il corsetto

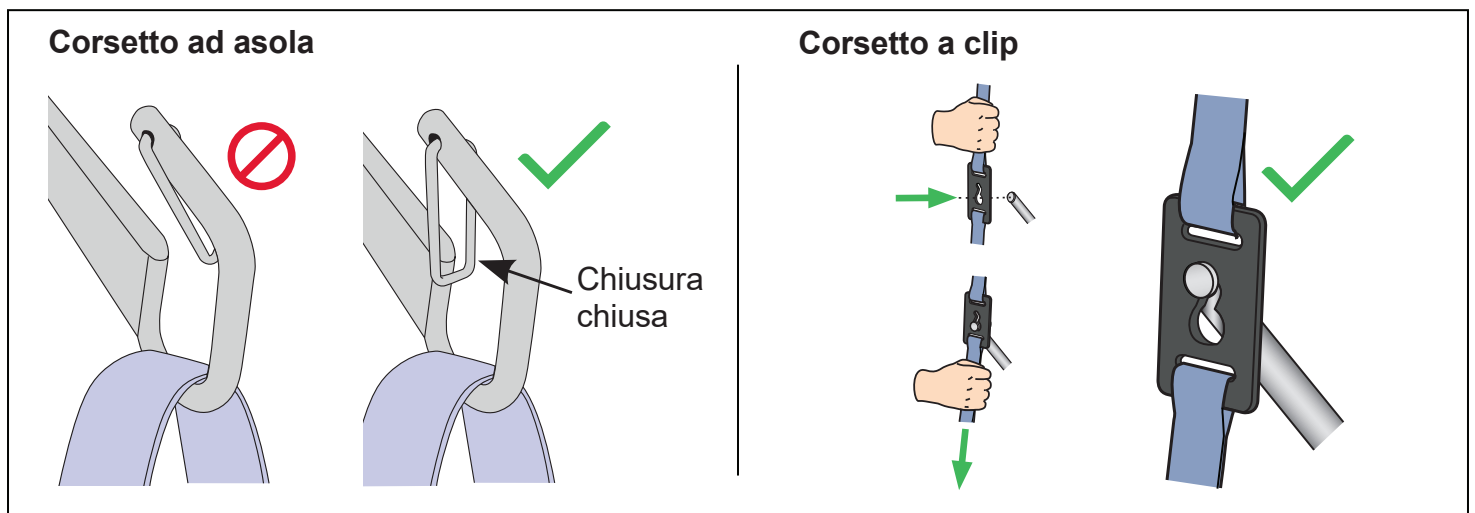

Sganciare il corsetto

